



STPS20L45CF/CW/CT/CFP/CG

LOW DROP POWER SCHOTTKY RECTIFIER

MAJOR PRODUCTS CHARACTERISTICS

$I_{F(AV)}$	2 x 10 A
V_{RRM}	45 V
$T_j(\text{max})$	150°C
$V_F(\text{max})$	0.5 V

FEATURES AND BENEFITS

- LOW FORWARD VOLTAGE DROP MEANING VERY SMALL CONDUCTION LOSSES
- LOW SWITCHING LOSSES ALLOWING HIGH FREQUENCY OPERATION
- INSULATED PACKAGE: ISOWATT220AB, TO-220FPAB
Insulating voltage = 2000V DC
Capacitance = 12pF
- AVALANCHE CAPABILITY SPECIFIED

DESCRIPTION

Dual center tap Schottky rectifiers designed for high frequency switched mode power supplies and DC to DC converters.

These devices are intended for use in low voltage, high frequency inverters, free-wheeling and polarity protection applications.

ABSOLUTE RATINGS (limiting values, per diode)

Symbol	Parameter			Value	Unit	
V_{RRM}	Repetitive peak reverse voltage			45	V	
$I_{F(RMS)}$	RMS forward current			30	A	
$I_{F(AV)}$	Average forward current	TO-220AB / D ² PAK	$T_c = 135^\circ\text{C}$	Per diode	10	A
		TO-247	$\delta = 0.5$	Per device	20	
		ISOWATT220AB	$T_c = 115^\circ\text{C}$	Per diode	10	A
		TO-220FPAB	$\delta = 0.5$	Per device	20	
I_{FSM}	Surge non repetitive forward current		$t_p = 10 \text{ ms}$ Sinusoidal	180	A	
I_{RRM}	Peak repetitive reverse current		$t_p = 2 \mu\text{s}$ square $F = 1\text{kHz}$	1	A	
I_{RSM}	Non repetitive peak reverse current		$t_p = 100 \mu\text{s}$ square	2	A	
P_{ARM}	Repetitive peak avalanche power		$t_p = 1 \mu\text{s}$ $T_j = 25^\circ\text{C}$	4000	W	
T_{stg}	Storage temperature range			- 65 to + 150	°C	
T_j	Maximum operating junction temperature *			150	°C	
dV/dt	Critical rate of rise of reverse voltage			10000	V/ μs	

* : $\frac{dP_{tot}}{dT_j} < \frac{1}{R_{th}(j-a)}$ thermal runaway condition for a diode on its own heatsink

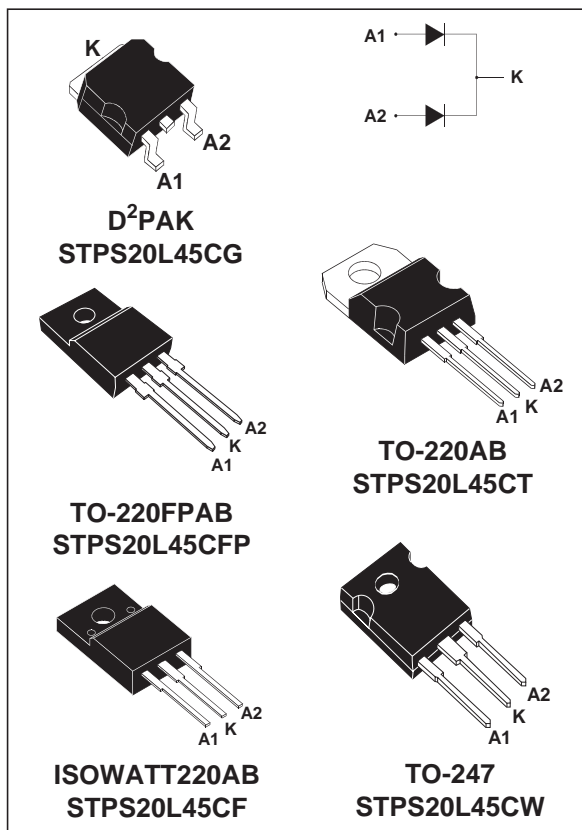

STPS20L45CF/CW/CT/CFP/CG

THERMAL RESISTANCES

Symbol	Parameter			Value	Unit
$R_{th(j-c)}$	Junction to case	ISOWATT220AB TO-220FPAB	Per diode	4.5	$^{\circ}\text{C}/\text{W}$
			Total	3.5	
			Coupling	2.5	
$R_{th(j-c)}$	Junction to case	TO-247	Per diode	2.2	$^{\circ}\text{C}/\text{W}$
			Total	1.20	
			Coupling	0.3	
$R_{th(j-c)}$	Junction to case	TO-220AB D ² PAK	Per diode	2.2	$^{\circ}\text{C}/\text{W}$
			Total	1.3	
			Coupling	0.3	

When the diodes 1 and 2 are used simultaneously :
 $\Delta T_j(\text{diode } 1) = P(\text{diode } 1) \times R_{th(j-c)}(\text{Per diode}) + P(\text{diode } 2) \times R_{th(c)}$

STATIC ELECTRICAL CHARACTERISTICS (per diode)

Symbol	Parameter	Tests Conditions		Min.	Typ.	Max.	Unit
I_R^*	Reverse leakage current	$T_j = 25^{\circ}\text{C}$	$V_R = V_{RRM}$			0.2	mA
		$T_j = 125^{\circ}\text{C}$			65	130	mA
V_F^*	Forward voltage drop	$T_j = 25^{\circ}\text{C}$	$I_F = 10 \text{ A}$			0.55	V
		$T_j = 125^{\circ}\text{C}$	$I_F = 10 \text{ A}$		0.44	0.5	
		$T_j = 25^{\circ}\text{C}$	$I_F = 20 \text{ A}$			0.73	
		$T_j = 125^{\circ}\text{C}$	$I_F = 20 \text{ A}$		0.62	0.72	

Pulse test : * $t_p = 380 \mu\text{s}$, $\delta < 2\%$

To evaluate the conduction losses use the following equation :
 $P = 0.28 \times I_{F(AV)} + 0.022 I_{F(RMS)}^2$

Fig. 1: Average forward power dissipation versus average forward current (per diode).

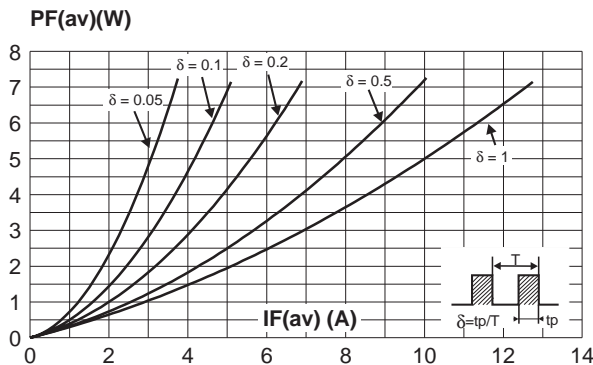

Fig. 2: Average forward current versus ambient temperature ($\delta = 0.5$, per diode).

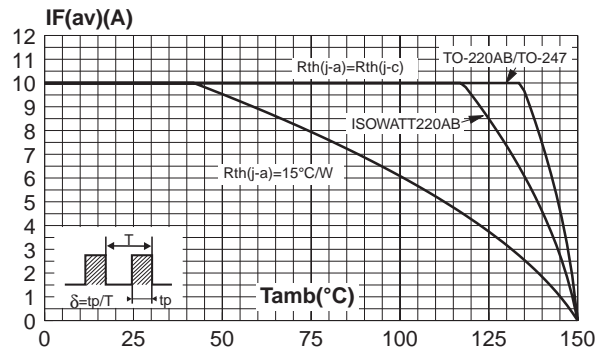

Fig. 3: Normalized avalanche power derating versus pulse duration.

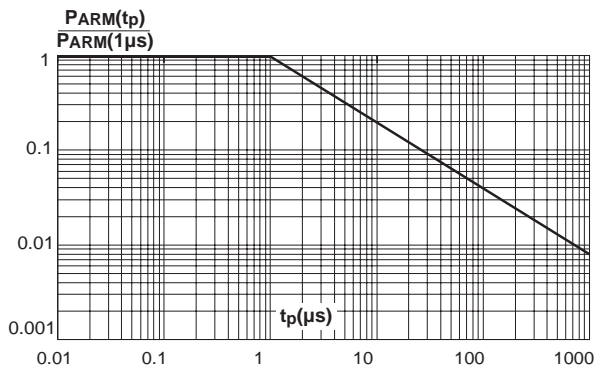

Fig. 4: Normalized avalanche power derating versus junction temperature.

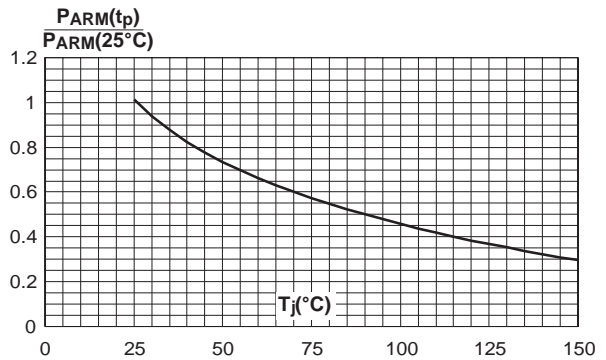

Fig. 5-1: Non repetitive surge peak forward current versus overload duration (maximum values, per diode, TO-220AB, TO-247, D²PAK).

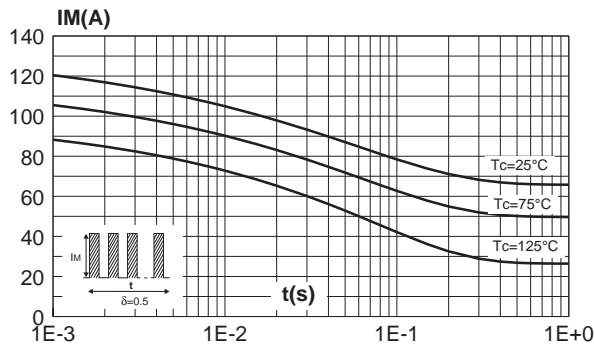

Fig. 5-2: Non repetitive surge peak forward current versus overload duration (maximum values, per diode, ISOWATT220AB, TO-220FPAB).

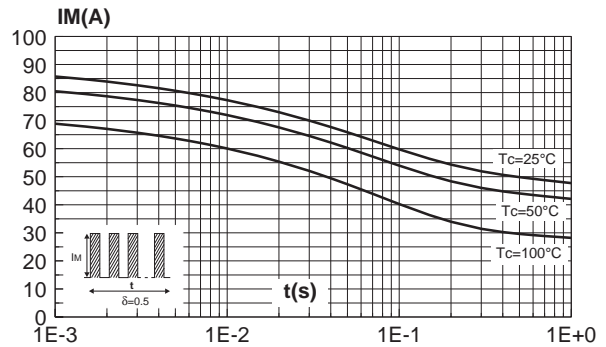

Fig. 6-1: Relative variation of thermal impedance junction to case versus pulse duration (TO-220AB, TO-247, D²PAK).

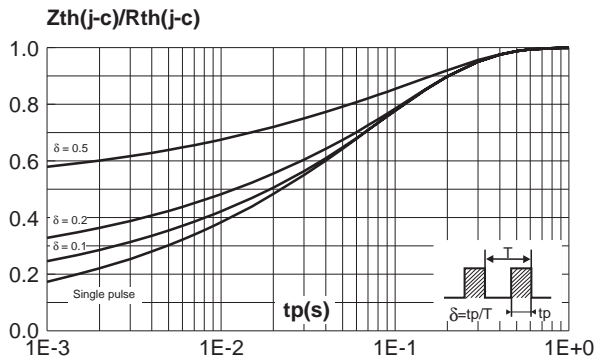

Fig. 6-2: Relative variation of thermal impedance junction to case versus pulse duration (ISOWATT220AB, TO-220FPAB).

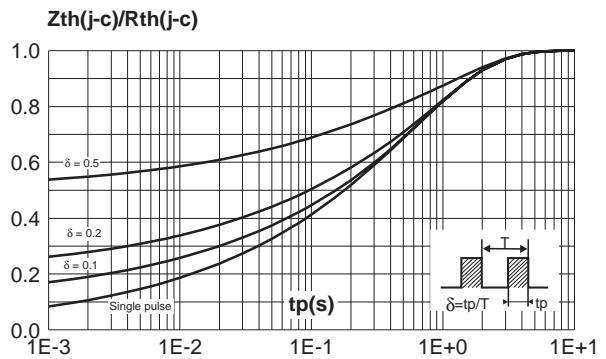

Fig. 7: Reverse leakage current versus reverse voltage applied (typical values, per diode).

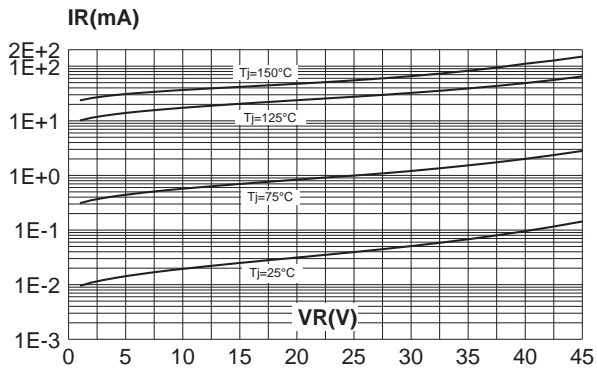

Fig. 8: Junction capacitance versus reverse voltage applied (typical values, per diode).

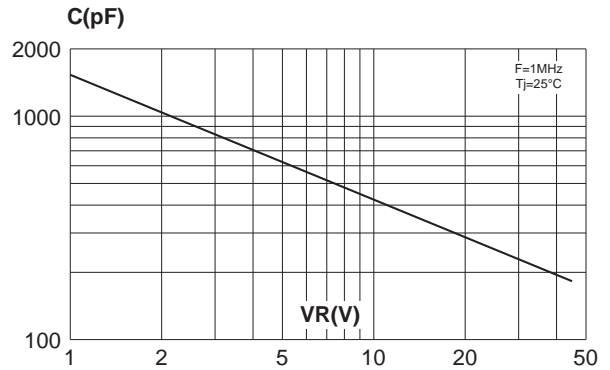

Fig. 9: Forward voltage drop versus forward current (maximum values) (per diode).

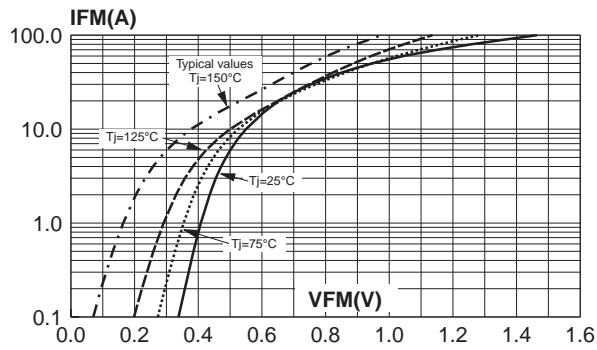
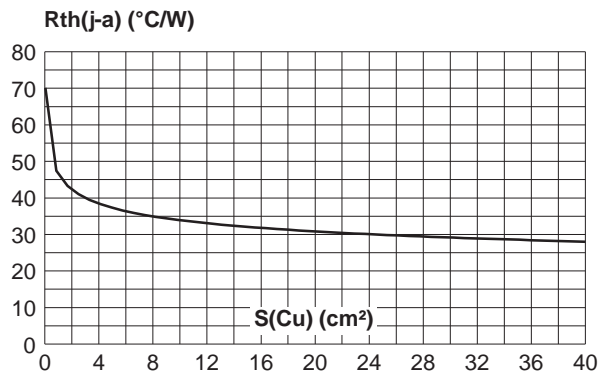
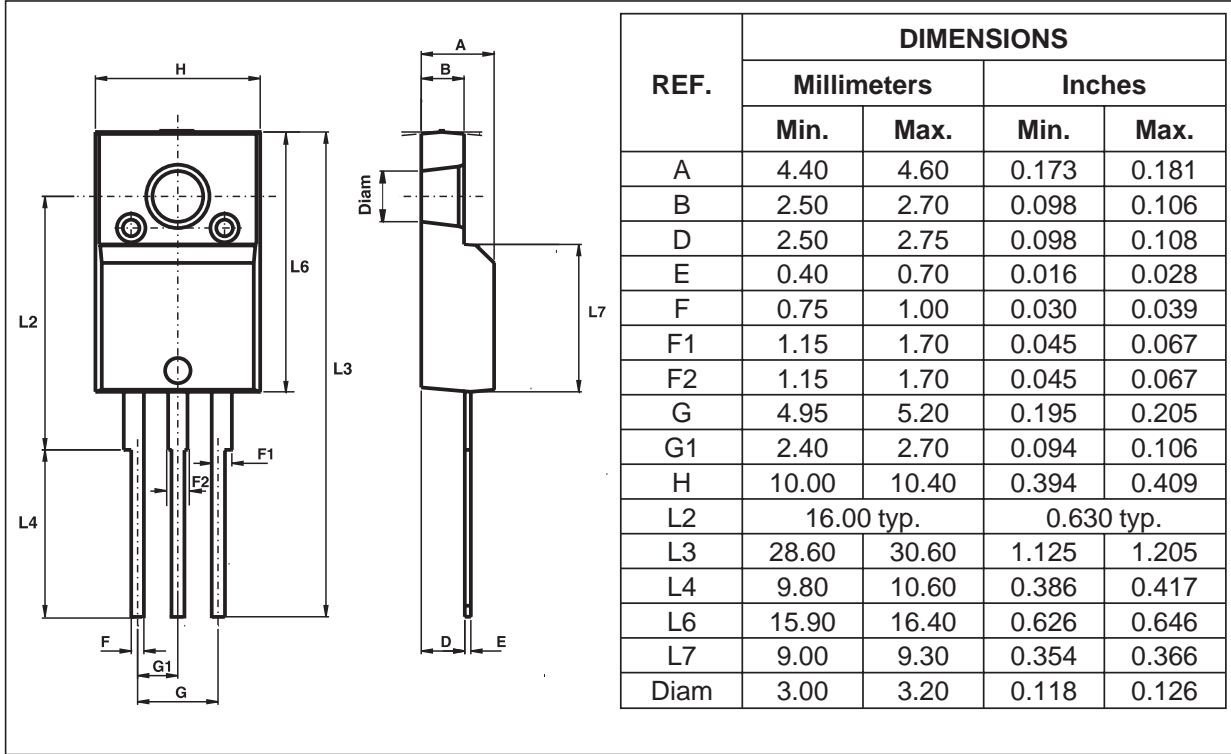

Fig. 10: Thermal resistance junction to ambient versus copper surface under tab (Epoxy printed circuit board FR4, copper thickness: 35µm) ($D^2\text{PAK}$).



PACKAGE MECHANICAL DATA
ISOWATT220AB



- Cooling method : C
- Recommended torque value : 0.55 m.N
- Maximum torque value : 0.70 m.N

STPS20L45CF/CW/CT/CFP/CG

PACKAGE MECHANICAL DATA
TO-220FPAB

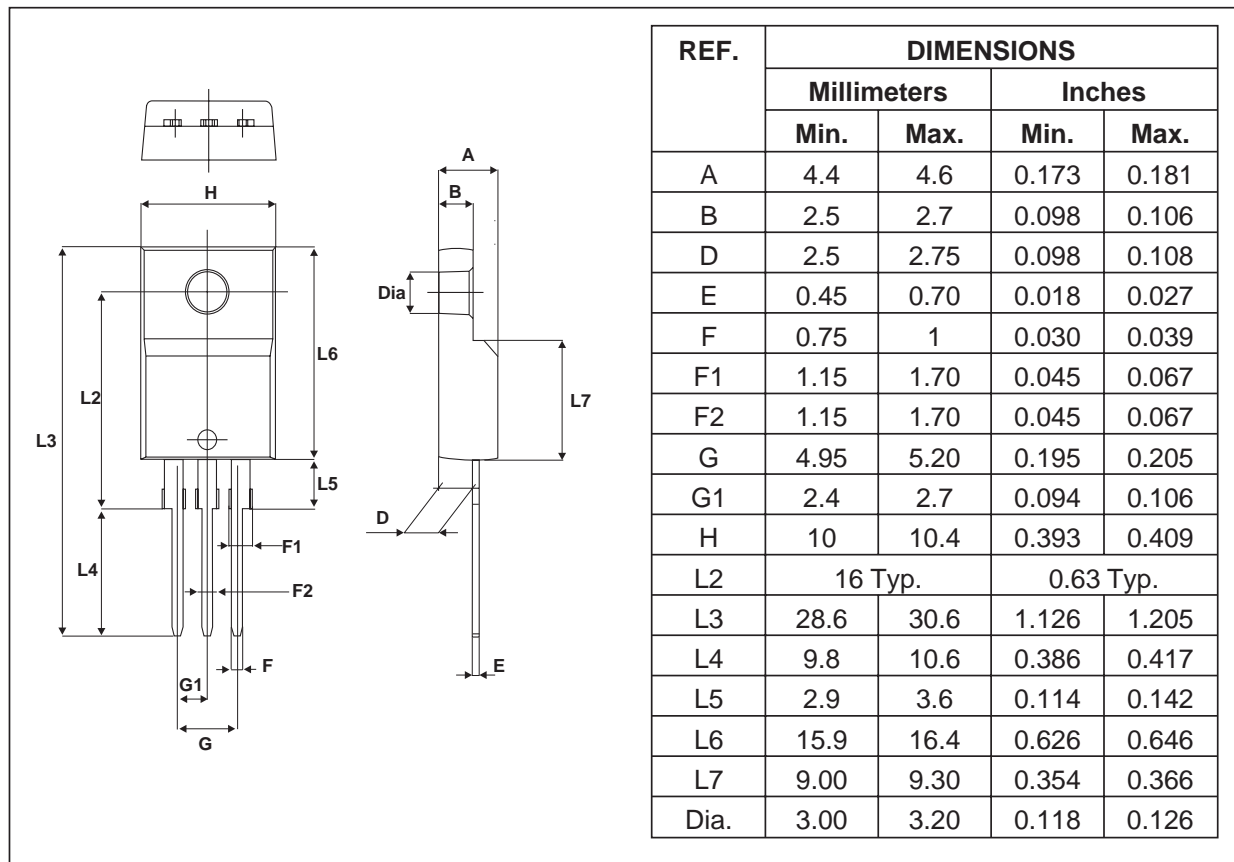

- Cooling method : C
- Recommended torque value : 0.55 m.N
- Maximum torque value : 0.70 m.N

PACKAGE MECHANICAL DATA
TO-220AB

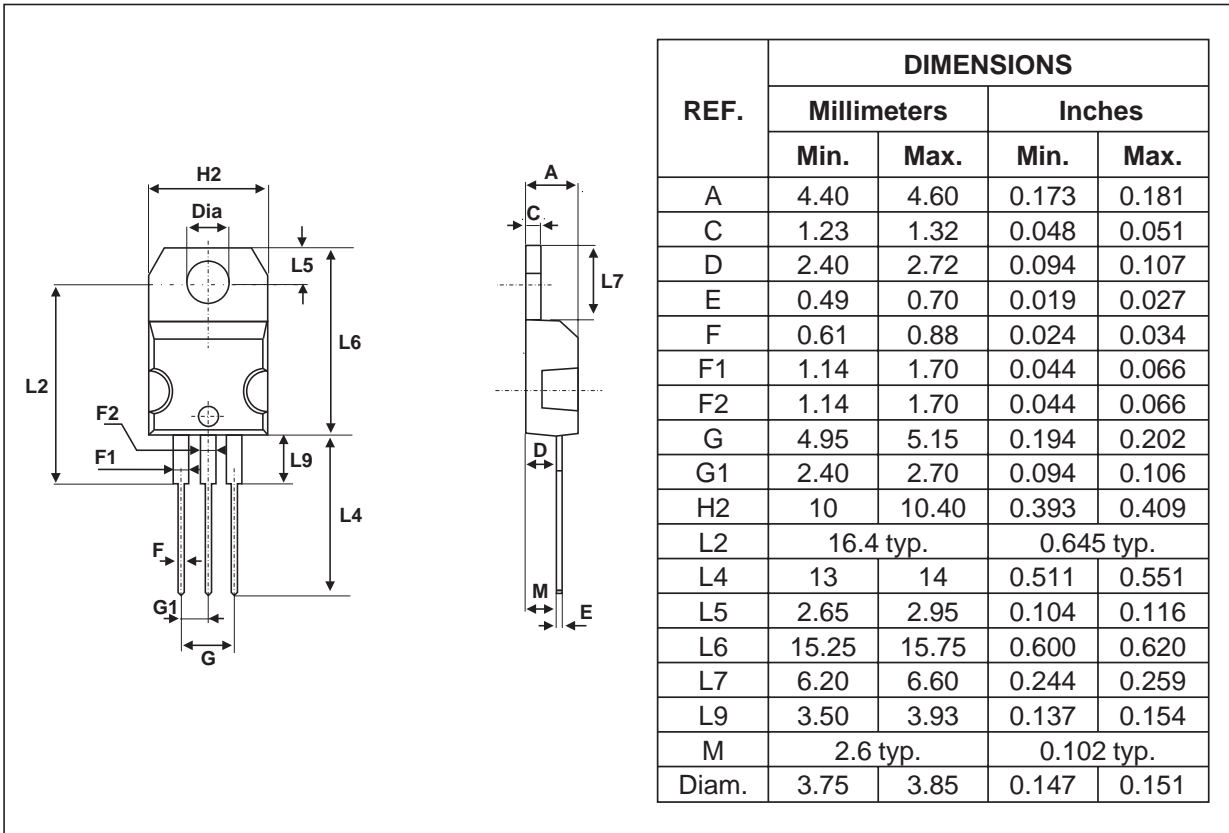

- Cooling method : C
- Recommended torque value : 0.55 m.N
- Maximum torque value : 0.70 m.N

STPS20L45CF/CW/CT/CFP/CG

PACKAGE MECHANICAL DATA
D²PAK

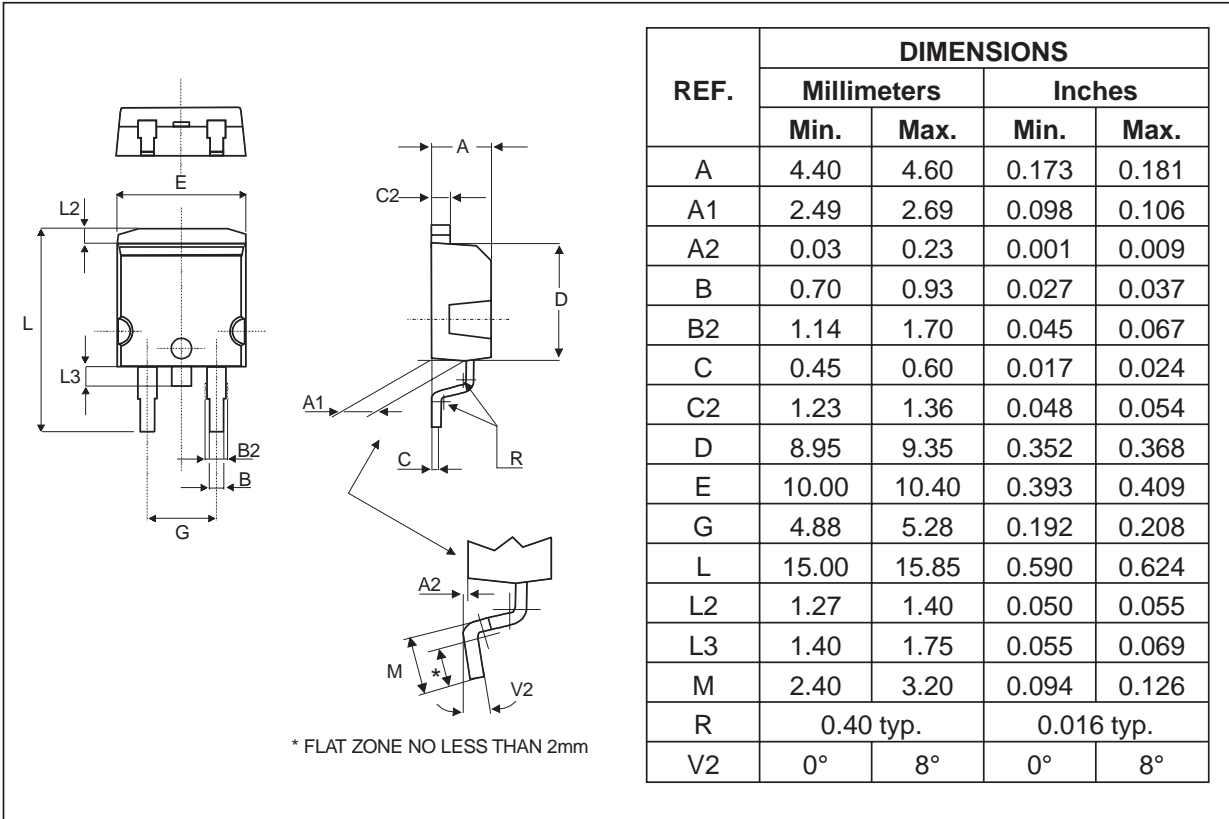

FOOTPRINT

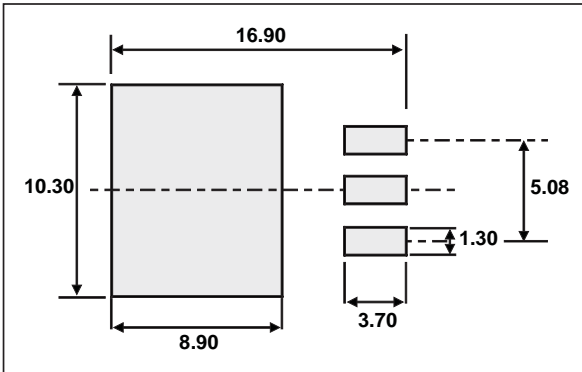

PACKAGE MECHANICAL DATA
TO-247

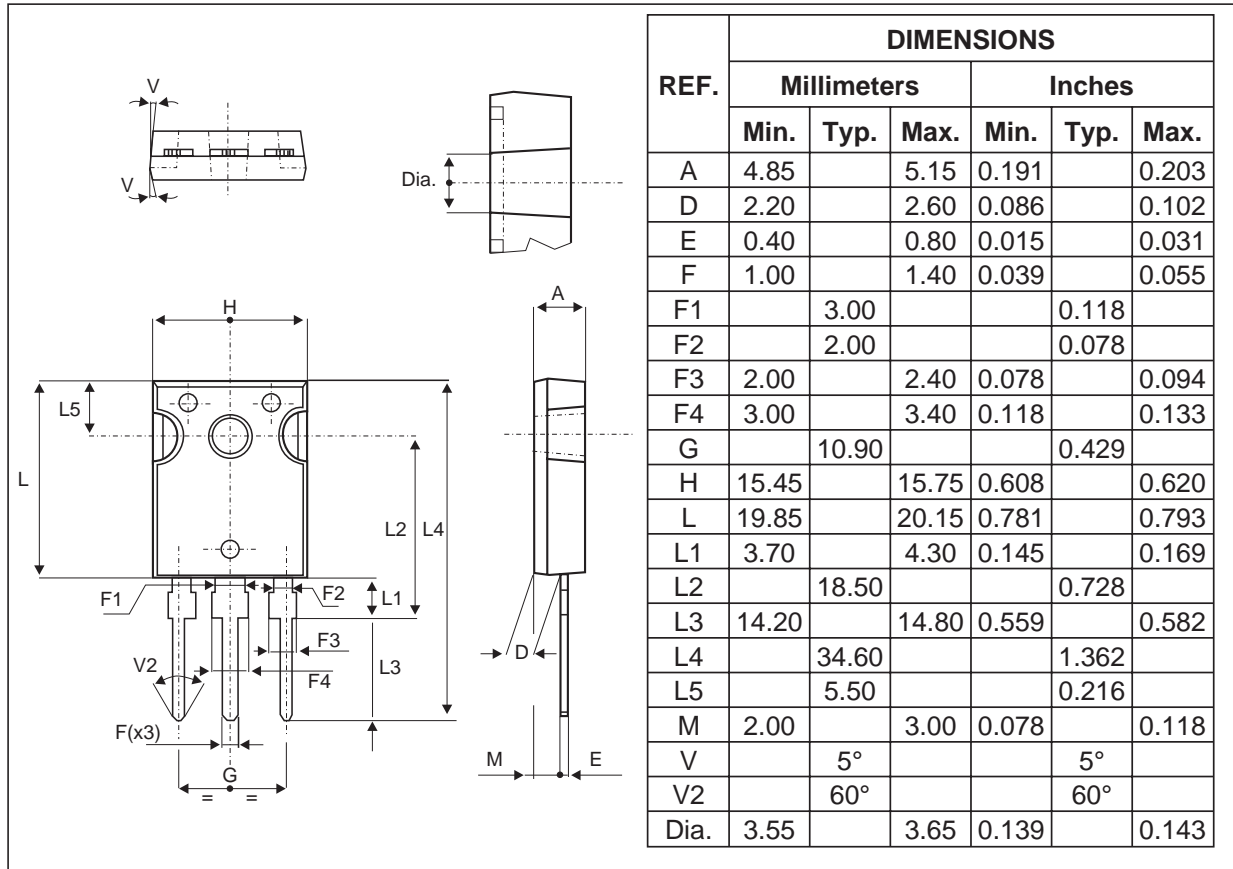

- Cooling method : C
- Recommended torque value : 0.8m.N
- Maximum torque value : 1.0m.N

Ordering type	Marking	Package	Weight	Base qty	Delivery mode
STPS20L45CF	STPS20L45CF	ISOWATT220AB	2.1g	50	Tube
STPS20L45CFP	STPS20L45CFP	TO-220FPAB	2g	50	Tube
STPS20L45CT	STPS20L45CT	TO-220AB	2g	50	Tube
STPS20L45CW	STPS20L45CW	TO-247	4.4g	30	Tube
STPS20L45CG	STPS20L45CG	D ² PAK	1.48g	50	Tube
STPS20L45CG-TR	STPS20L45CG	D ² PAK	1.48g	1000	Tape & Reel

- Epoxy meets UL94,V0

Information furnished is believed to be accurate and reliable. However, STMicroelectronics assumes no responsibility for the consequences of use of such information nor for any infringement of patents or other rights of third parties which may result from its use. No license is granted by implication or otherwise under any patent or patent rights of STMicroelectronics. Specifications mentioned in this publication are subject to change without notice. This publication supersedes and replaces all information previously supplied. STMicroelectronics products are not authorized for use as critical components in life support devices or systems without express written approval of STMicroelectronics.

The ST logo is a registered trademark of STMicroelectronics
 © 2003 STMicroelectronics - Printed in Italy - All rights reserved.
 STMicroelectronics GROUP OF COMPANIES
 Australia - Brazil - Canada - China - Finland - France - Germany
 Hong Kong - India - Israel - Italy - Japan - Malaysia - Malta - Morocco - Singapore
 Spain - Sweden - Switzerland - United Kingdom - United States.

<http://www.st.com>

